

2.4G Wireless Transceiver Module  
CE, FCC, ETSI Approval

## Product Specification

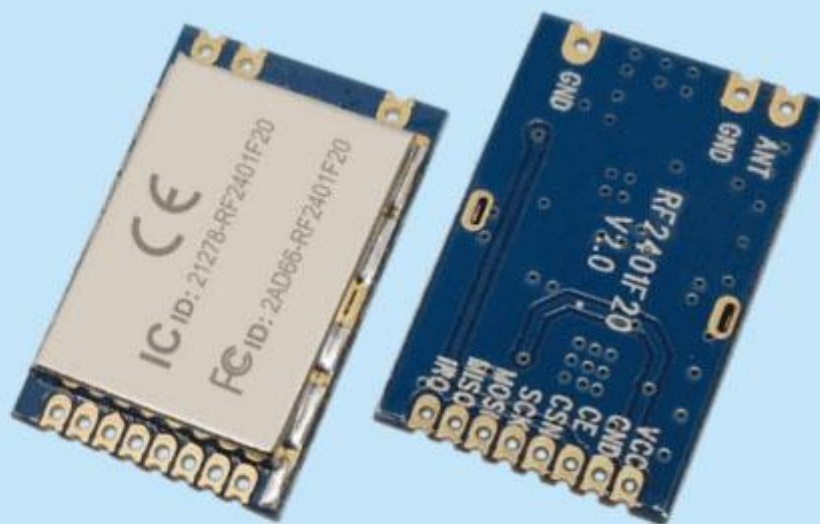

## Catalog

1. Description.....	- 3 -
2. Features.....	- 3 -
3. Application.....	- 3 -
4. Schematic.....	- 3 -
5. Electrical Specifications.....	- 4 -
6. Pin Definition.....	- 4 -
7. Antenna.....	- 5 -
8. Mechanical Dimension.....	- 6 -
Appendix 1: Demo Board.....	- 6 -
Appendix 2: SMD Reflow Chart.....	- 8 -

### Note: Revision History

Revision	Date	Comment
V1.0	2015-10-16	First release
V2.0	2016-8-5	Updated layout
V2.1	2017-06	Logo updated
V2.2	2017-11	Refere to Layout as below
V2.3	2018-12-22	Updated Pin Definition
V2.4	2019-9	Update size
V2.5	2020-2-26	Update Precautions

## 1. Description

RF2401F20 Module is a high integrated wireless module, which worked in 2.4GHz of ISM band. RF2401F20 adopts Nordic's RF chip nRF24L01+ and high efficiency RF amplifier. The feature of high data rate (maximum 2Mbps), good sensitivity (-102 dBm) and high output power (+20dBm) but low harmonic and low unexpected radiation extend the range and improve the link performance.

★ This module got CE、FCC、ETSI approvals.

## 2. Features

- Frequency Range: 2400-2525MHz
- Maximum power output: 20dBm
- Sensitivity up to: -102dBm@250Kbps
- Data rate: 250K, 1Mbps, 2Mbps
- GFSK Modulation, 126 Channel
- FIFO: 32bytes
- Ultra low power off mode
- Support functions of frequency hopping
- Timing wake-up function
- Internal integrated voltage regulator
- Operating voltage range: 1.9-3.6 V
- Operating temperature range: -40~+85 °C

## 3. Application

- Wireless remote control
- Smart Home
- Toy control
- Tire Pressure Monitoring
- health monitoring
- Tag reader

## 4. Schematic

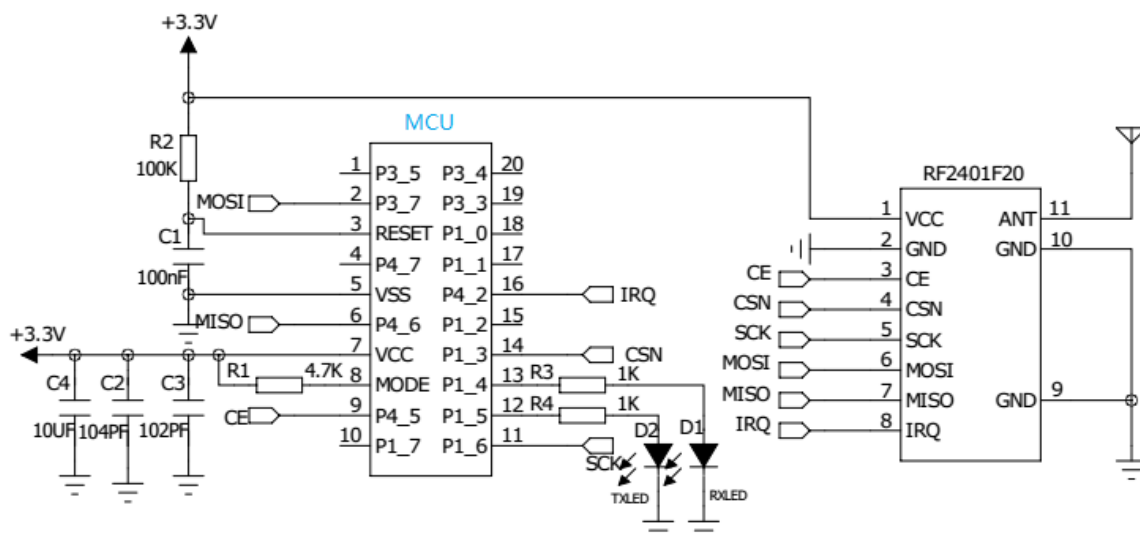

## 5. Electrical Specifications

★ Below parameters is measured at 3.0V

Parameter	Min.	Type.	Max.	Unit	Conditions
<b>Operation conditions</b>					
Operating voltage range	1.9	3.3	3.6	V	
Operating temperature range	-40		85	°C	
<b>Current consumption</b>					
RX Current		23.5	24	mA	
TX Current		135	150	mA	@20dBm
Sleep Current		<1		uA	
<b>RF Parameters</b>					
Frequency range	2400		2525	MHz	
Modulation rate	250		2000	Kbps	GFSK
Output power	4		20	dBm	Power 0=5dBm,3=20dBm
Maximum output power	18.5	20		dBm	
RX sensitivity	-100	-102		dBm	@data=250kbps

## 6. Pin Definition

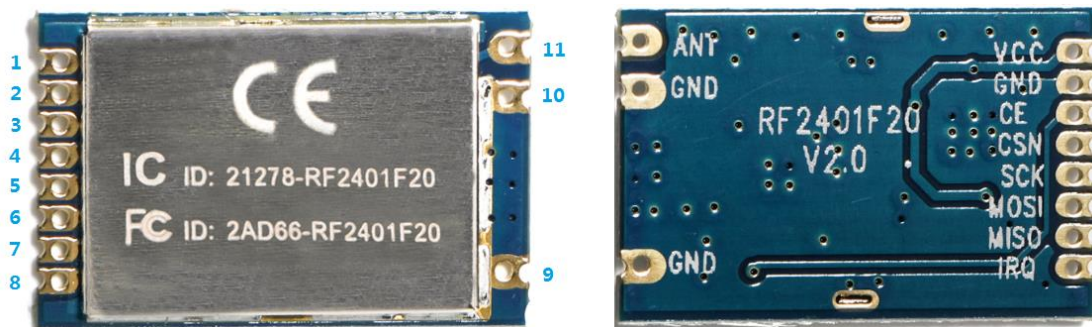

Pin No.	in Definition	Description
1	VCC	Connect to VCC (1.9-3.6V)
2	GND	Connect to ground
3	CE	Chip enable
4	CSN	CSN of SPI interface
5	SCK	SCK or SPI interface
6	MOSI	MOSI of SPI interface
7	MISO	MISO of SPI interface
8	IRQ	Interrupt output, active low
9	GND	Connect to ground
10	GND	Connect to ground
11	ANT	Connect 50ohm coaxial antenna



8. Mechanical Dimension

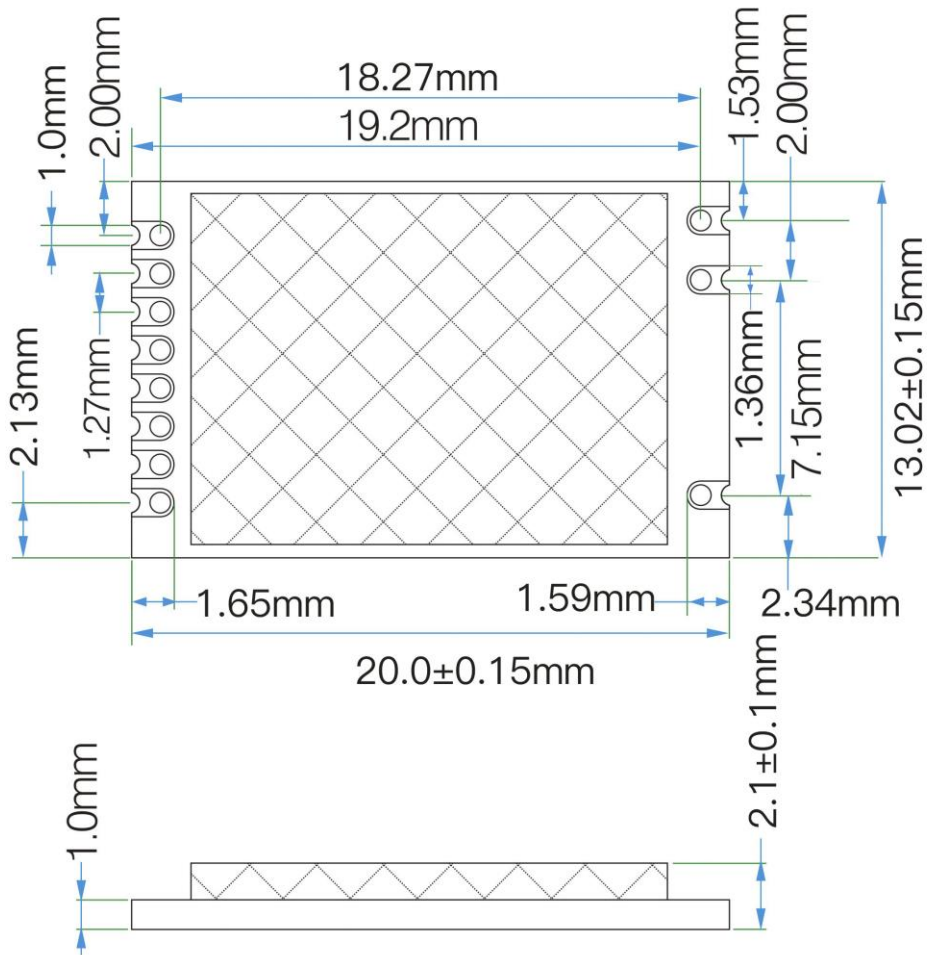

Appendix 1: Demo Board

The module is equipped with a standard DEMO board for customer to debug the program and test distance.

It shows as below:

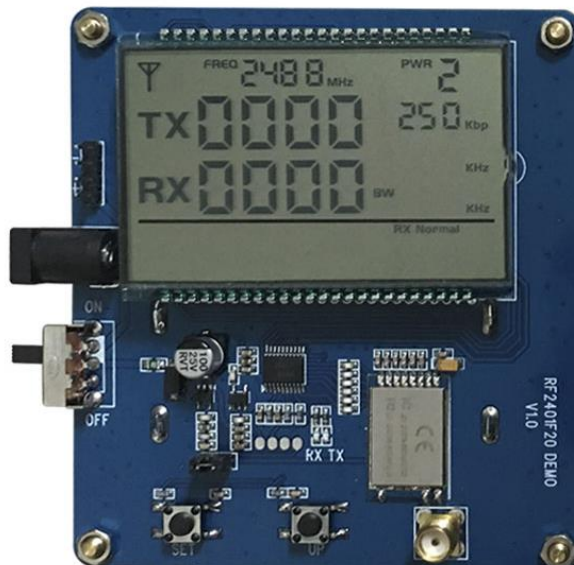



The LCD Full Segment is as below:

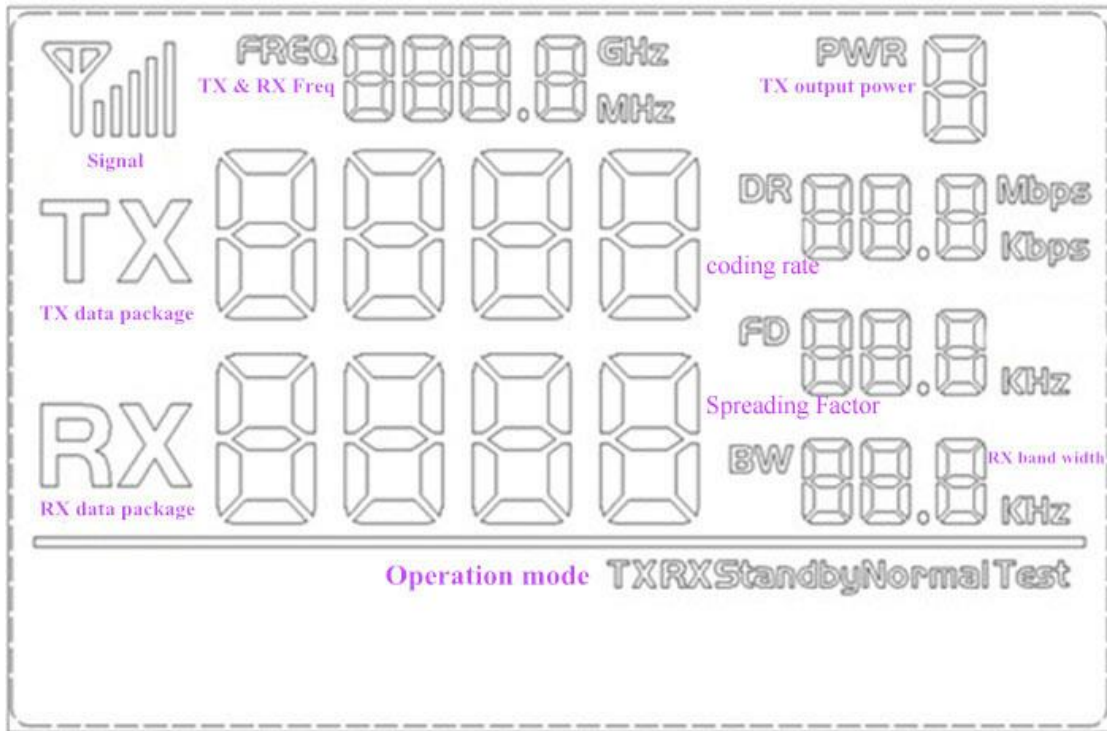

Users can set the parameters of the RF module such as working mode /frequency / transmitter power / transmission data rate through the buttons, and measure the wireless communication distance.

#### ➤ Working Mode:

- 1) Master Mode: Send 1 packet per second, and waiting for the acknowledge;
- 2) Slave Mode: Stay in Rx mode to wait for the data from the master, it will send back the acknowledged signal after received the data from the master.
- 3) Tx Test Mode: RF module continuously transmit signal;
- 4) Rx Test Mode: RF module is always in Rx mode;
- 5) Standby Mode: RF module is always in standby state.

#### ➤ Button Operation:

- 1) [SET] Button

Press the [SET] button to enter into setting mode; Or press the [SET] button to be out of the setting mode upon the last parameter is done.

- 2) [UP/Down] Button

In setting mode, press the [UP/Down] button to increase/decrease the value of flash icon.

Note: The DEMO board has FLASH memory inside, all the setting parameters will be saved automatically and keep unchanged even power-off.

**Appendix 2: SMD Reflow Chart**

We recommend you should obey the IPC related standards in setting the reflow profile:

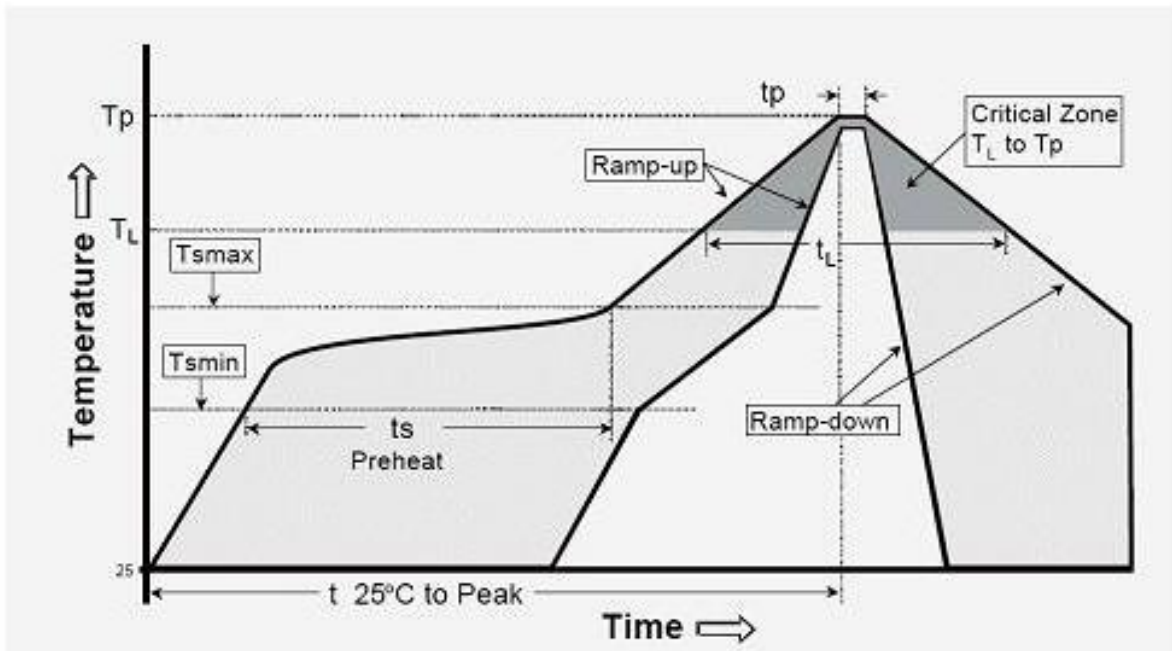

IPC/JEDEC J-STD-020B the condition for lead-free reflow soldering	big size components (thickness $\geq 2.5\text{mm}$ )
The ramp-up rate ( $T_L$ to $T_p$ )	$3^\circ\text{C/s}$ (max.)
preheat temperature	
- Temperature minimum ( $T_{smin}$ )	$150^\circ\text{C}$
- Temperature maximum ( $T_{smax}$ )	$200^\circ\text{C}$
- preheat time ( $t_s$ )	$60\sim 180\text{s}$
Average ramp-up rate ( $T_{smax}$ to $T_p$ )	$3^\circ\text{C/s}$ (Max.)
- Liquidous temperature ( $T_L$ )	$217^\circ\text{C}$
- Time at liquidous ( $t_L$ )	$60\sim 150$ second
peak temperature ( $T_p$ )	$245\pm 5^\circ\text{C}$