

100mW Ultra-Small Size Long Range
Wireless Transceiver Module

Product Specification

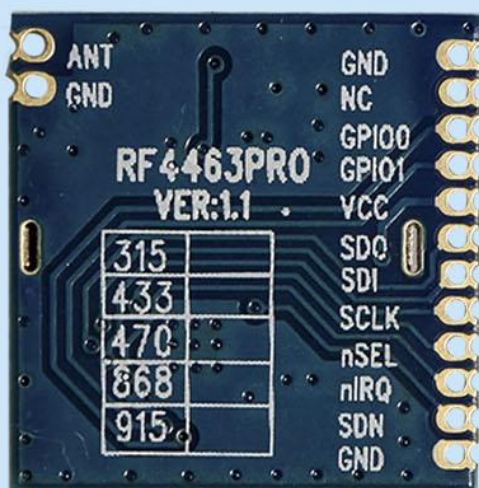

Catalog

1. Description.....	- 3 -
2. Features	- 3 -
3. Application.....	- 3 -
4. Electrical specifications	- 4 -
5. Schematic.....	- 4 -
6. Pin Configuration.....	- 5 -
7. Antenna	- 6 -
8. Mechanical Dimension(Unit: mm)	- 6 -
9. Products ordering Information.....	- 7 -
10. FAQ.....	- 7 -
Appendix 1: SMD Reflow Chart	- 8 -
Appendix 2: Demo Board	- 9 -

Note: Revision History

Revision	Date	Comment
V1.0	2015-10-16	First release
V2.0	2016-8-5	Updated layout
V2.1	2017-06	Logo updated
V2.2	2018-12-13	Correct foot description
V2.3	2019-7-3	Update picture

1. Description

RF4463PRO adopts Silicon Lab EzradioPro2 RF transceiver Si4463, which is a highly integrated wireless ISM band transceiver chip. The features of high sensitivity (-126 dBm), +20 dBm output power, low current consumption, 10PPM crystal, and good RF matching circuit make this module work well in hot/cold environment with reliable communication and long distance.

2. Features

- Frequency Range: 315/433/470/868/915 (Customizable 142-1050 MHZ)
- Sensitivity up to -126 dBm
- Maximum output power: 20dBm
- 10mA@receiver mode
- Data transfer rate: 0.1-1000 kbps
- FSK, GFSK and OOK Modulation mode
- 1.8-3.6 V Power supply
- Ultra-low consumption shutdown mode
- Digital received signal strength indicator (RSSI)
- Timed wake-up function
- Excellent antenna match circuit and bi-direction communication
- Configurable packet structure
- Preamble detection
- 64/128byte transmit and receive data register (FIFO)
- Low-battery detection
- Temperature sensor and 8-bit analog-to-digital converters
- Operating Temperature Range: -40 ~ + 85 °C
- Integrated voltage regulator
- Frequency hopping
- Power-on reset function
- Built-in crystal adjustment function

3. Application

- Remote control
- Remote meter reading
- Home security alarm and remote keyless entry
- industrial control
- home automation remote sensing
- individual data records
- toys control
- sensor network
- tire pressure monitoring
- health monitoring
- wireless PC peripherals
- tag reading and writing

4. Electrical specifications

Parameter	Min	Typ.	Max	Unite	Condition
Working condition					
Working voltage range	1.8	3.3	3.6	V	
Temperature voltage	-40		85	°C	
Current consumption					
Receiving current		13.5		mA	High performance mode
Receiving current		10.7		mA	Low power mode
Transmitting current		85		mA	@20dBm
Sleep current		<0.1		uA	
parameter					
Frequency range	403	433	463	MHZ	@433MHZ
	838	868	898	MHZ	@868MHZ
Modulation rate	0.123		1000	Kbps	FSK
Output power range	-5		20	dBm	
Receiving sensitivity		-126		dBm	@data=500bps,Fdev=3kHz

5. Schematic

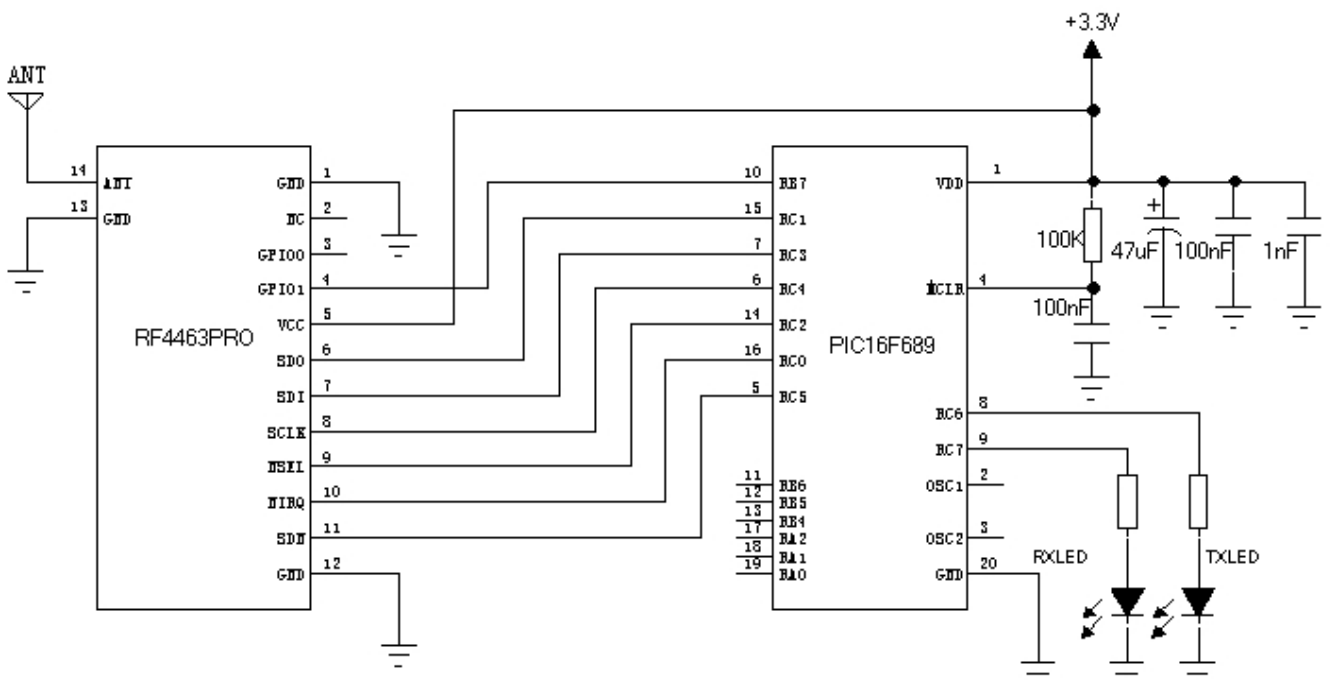

6. Pin Configuration

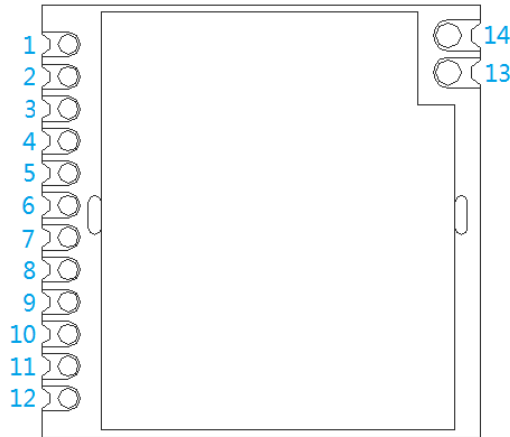

Pin NO.	Pin name	Description
1	GND	power ground
2	NC	NC
3	GPIO0	GPIO0 of Si4463
4	GPIO1	GPIO1 of Si4463
5	VCC	Positive power supply 3.3V
6	SDO	Serial data out for SPI interface.
7	SDI	Serial data in for SPI interface
8	SCLK	Serial data clock for SPI interface
9	nSEL	Serial data selection for SPI interfaces.
10	nIRQ	Interrupt output
11	SDN	Power down control. SDN = 1, power down SDN = 0, normal working
12	GND	power ground
13	GND	power ground
14	ANT	Connect with 50 ohm coaxial antenna

Note: The GPIO2, GPIO3 of the Si4463 is connected to the antenna switch on the module. The detailed method on how to use these two Port, please contact the sales engineer to take reference to the Demo Code

7. Antenna

The antenna is important in the communication. For this module, the match impedance is 50 Ohm. We have many kinds of antenna for customer to choose, please contact the corresponding sales engineer for help, or find the antenna in our website.

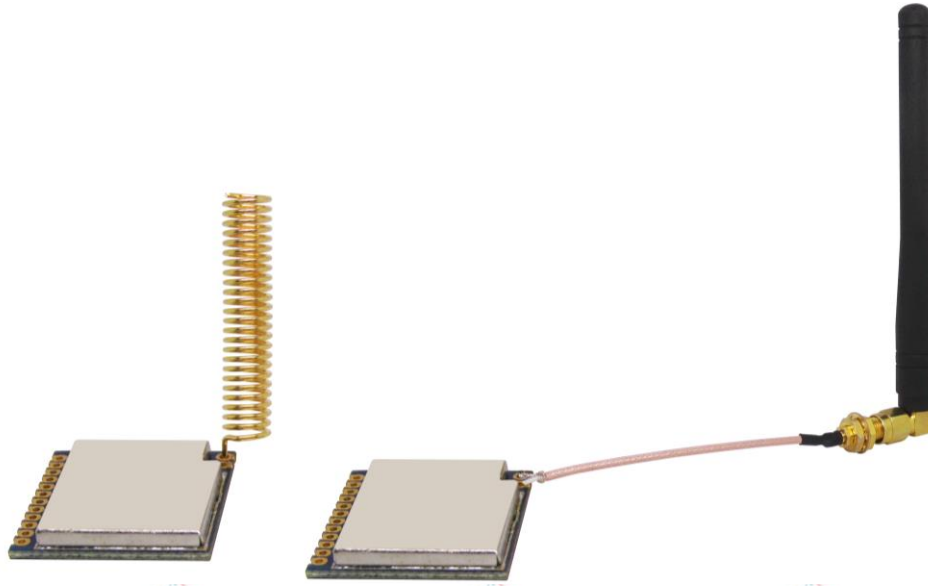

★ Tips for antenna:

- Don't close to the ground, metal, magnet, big current;
- If you are using the sucker antenna, pull the wire as straight as possible, the sucker foundation should stick with metal

8. Mechanical Dimension(Unit: mm)

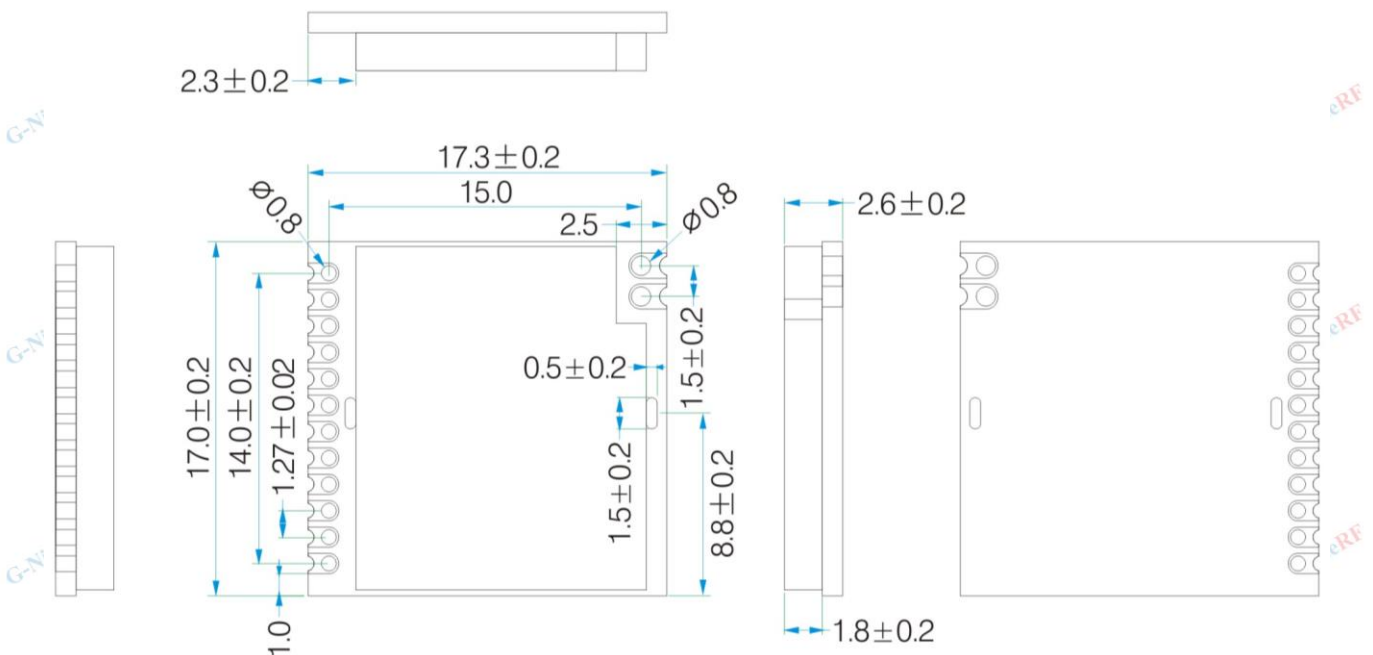

9. Products ordering Information

RF4463PRO-433

Module Model

Frequency

For example: If the customer needs a patch module small crystal 433MHZ band module that order model: RF4463PRO-433

Module Model	Frequency
RF4463PRO-433	433MHZ
RF4463PRO-490	490MHZ
RF4463PRO-868	868MHZ
RF4463PRO-915	915MHZ

10. FAQ

- Why module can not communicate properly?
 - a) Check if the band, channel, rate, NET ID has set to the same;
 - b) Check if there is power connection error;
 - c) Check if the module is enabled (CS high);
 - d) Check if the antenna connection is not correct;
 - e) Check if the module is damaged.

- Why transmission distance is not far as it should be?
 - a) Power supply ripple is too large;
 - b) The antenna types do not match, or not properly installed;
 - c) The surrounding environment is harsh, strong interference sources;
 - d) Surrounding co-channel interference;

Appendix 1: SMD Reflow Chart

We recommend you should obey the IPC related standards in setting the reflow profile:

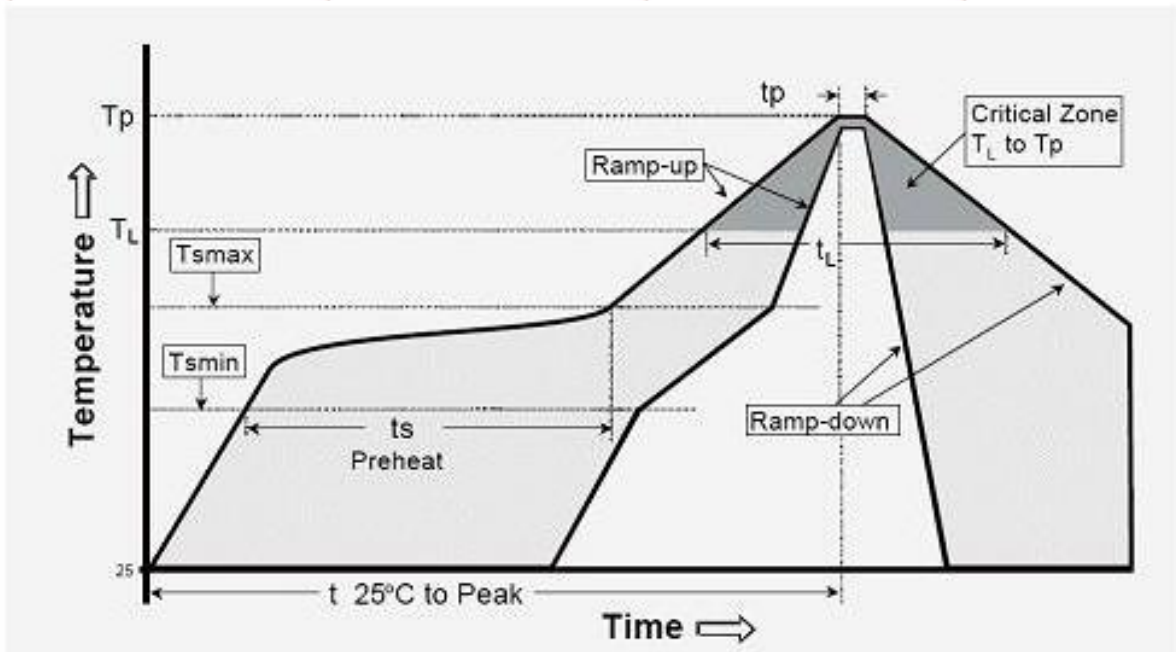

IPC/JEDEC J-STD-020B the condition for lead-free reflow soldering	big size components (thickness $\geq 2.5\text{mm}$)
The ramp-up rate (T_L to T_p)	3°C/s (max.)
preheat temperature	
- Temperature minimum (T_{min})	150°C
- Temperature maximum (T_{max})	200°C
- preheat time (t_s)	60~180s
Average ramp-up rate (T_{max} to T_p)	3°C/s (Max.)
- Liquidous temperature (T_L)	217°C
- Time at liquidous (t_L)	60~150 second
peak temperature (T_p)	245+/-5°C

Appendix 2: Demo Board

The module is equipped with a standard DEMO board for customer to debug the program and test distance. It shows as below:

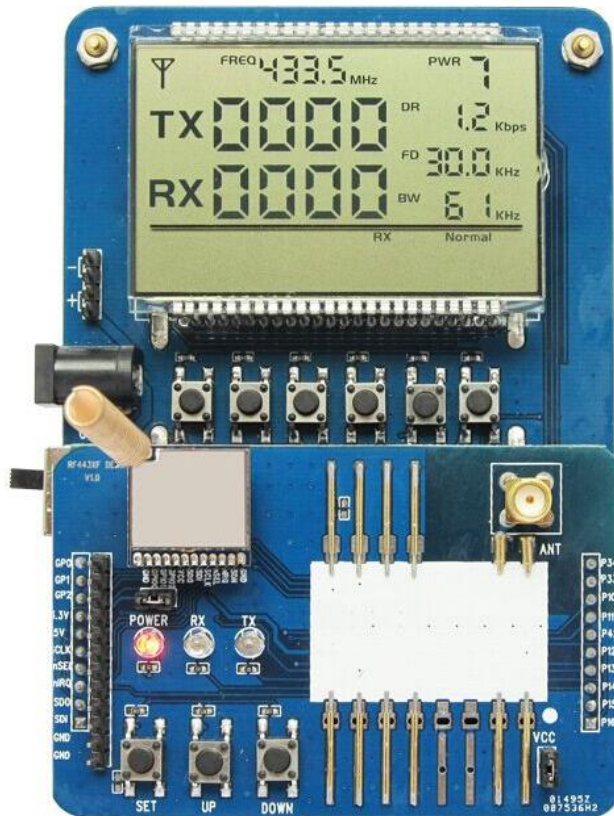

The LCD Full Segment is as below:

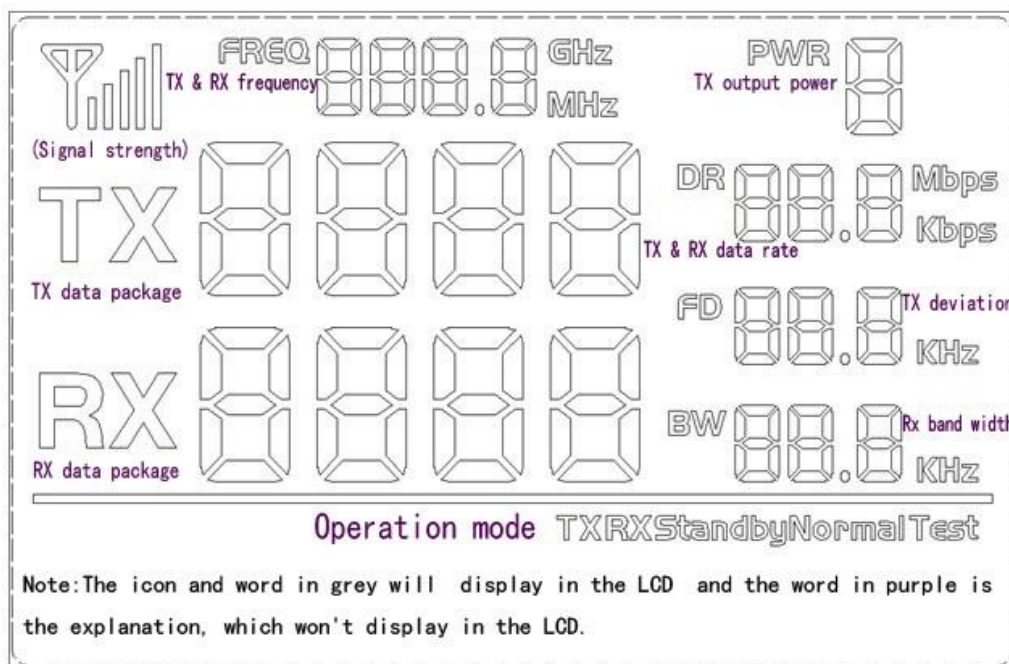

Users can set the parameters of the RF module such as frequency / transmitter power / transmission data rate / working mode through the buttons, and measure the wireless communication distance. Also, all the connection Pins of the module are extended to the demo board, user can use oscilloscope, multi-meter to monitor the operation of the RF module, which is very useful for software programming.

➤ Working Mode

There are 5 working modes in the DEMO. They are: Master mode, Slave mode, Tx Test mode, Rx test mode, Standby mode, accordingly, they are displayed on the LCD as: Tx normal / Rx normal / Tx Test / Rx test / Standby. When one packet is transmitted, the Red LED will blink once, the number of Tx packets will increase; when one packet is received, the Blue LED will blink once, the number of Rx packets will increase.

- 1) Master Mode: Send 1 packet per second, and waiting for the acknowledge;
- 2) Slave Mode: Stay in Rx mode to wait for the data from the master, it will send back the acknowledged signal after received the data from the master.
- 3) Tx Test Mode: RF module continuously transmit signal;
- 4) Rx Test Mode: RF module is always in Rx mode;
- 5) Standby Mode: RF module is always in standby state.

➤ Button Operation

1) [SET] Button

Press the [SET] button to enter setting mode if not in setting mode. In setting mode, press [SET] button to toggle between the set parameters: frequency /output power / data rate / working mode. The related LCD ICON will flash to indicate.

2) [UP] Button

In setting mode, press the [UP] button to increase the value of flash icon.

3) [Down] Button

In setting mode, press the [Down] button to decrease the value of flash icon.

Note: The DEMO board has FLASH memory inside, all the setting parameters will be saved automatically and keep unchanged even power-off.