

100mW Long Range Spread Spectrum Modulation
Wireless Transceiver Module

Product Specification

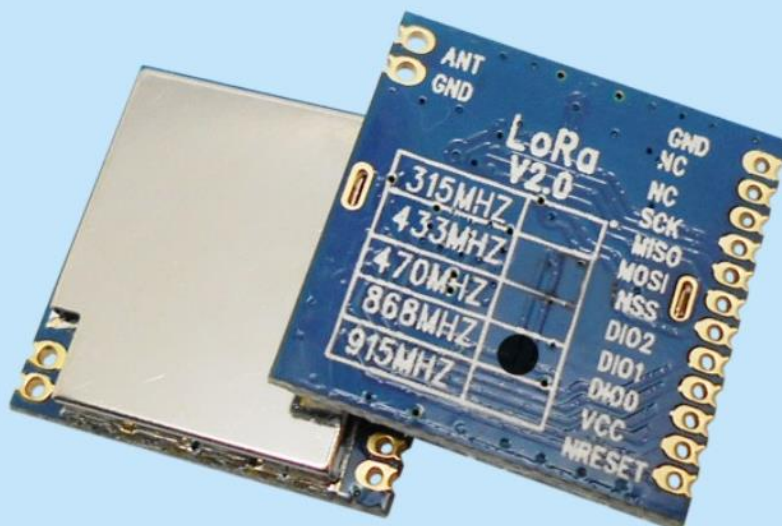

Catalogue

1.	Overview	- 3 -
2.	Features	- 3 -
3.	Applications	- 3 -
4.	Electrical Characteristics.....	- 4 -
5.	Schematic	- 5 -
6.	Speed rate correlation table.....	- 5 -
7.	Pin definition	- 6 -
8.	Accessories.....	- 7 -
9.	Mechanical Dimensions(Unit: mm).....	- 7 -
10.	Order information.....	- 8 -
	Appendix 1: SMD Reflow Chart	- 9 -
	Appendix 2: PCB board.....	- 10 -

Note: Revision History

Revision	Date	Comment
V1.0	2015-4-2	First release
V1.1	2016-4-26	Content Added
V2.0	2016-5-31	PCB updated to V2.0, ESD protection added and antenna switch controlled by RF chip
V2.1	2017-06	Logo updated
V2.2	2018-12-14	Correct PIN description

1. Overview

LoRa1276 integrates Semtech RF transceiver chip SX1276, which adopts LoRa TM Spread Spectrum modulation frequency hopping technique. The features of long distance and high sensitivity (-139 dBm) make this module perform better than FSK and GFSK module. Multi-signal won't affect each other even in crowd frequency environment; it comes with strong anti-interference performance. This module is 100mW and ultra small size, widely used in AMR , remote industrial control filed.

For better security, the module uses AES128 encryption to transmit the data to gateways, where it is being decrypted, and retranslated to an objective node.

Note: Two versions for option, V1.1 and V2.0, please choose the version you need.

PCB Version	Control of Antenna switch	ESD Protection	Hardware	Firmware
V1.1	TXEN, RXEN controlled by external MCU	None	Pin, dimensions compatible	V2.0 compatible with V1.1
V2.0	Integrated control by internal chips	Yes		

2. Features

- Frequency Range: 868 / 915 MHz
- Sensitivity up to -139dBm @Lora
- Maximum output power: 20 dBm
- 13mA@receiver mode
- Sleep current <200 nA
- Data transfer rate: @FSK,1.2-300 Kbps
- @Lora TM, 0.018-37.5 Kbps
- Lora TM, FSK, GFSK & OOK Modulation mode
- Built-in ESD Protection
- 127 dB Dynamic Range RSSI
- Packet engine up to 256 bytes with FIFO and CRC
- Hopping frequency
- Built-in temperature sensor and low battery indicator
- Excellent blocking immunity
- Operating Temperature Range: -40 ~ + 85 °C

3. Applications

- Remote meter reading
- Industrial control
- Home automation remote sensing
- Toys control
- Sensor network
- Tire pressure monitoring
- Health monitoring
- Wireless PC peripherals

4. Electrical Characteristics

Parameter	Min	Typ.	Max.	Unit	Condition
Operation condition					
Working voltage	1.8	3.3	3.7	V	
Temperature range	-40		85	°C	
Current consumption					
RX current		10.8		mA	
TX current		120		mA	@20dBm
Sleep current		<0.2		uA	
RF parameter					
Frequency range	800	868	900	MHz	@868MHZ
	900	915	1000	MHz	@915MHZ
Modulation rate	1.2		300	Kbps	FSK
	0.018		37.5	Kbps	LoraTM
Output power range	-1		20	dBm	
Receiving sensitivity		-123		dBm	@FSK data=1.2kbps, Fdev=10kHz
		-139		dBm	@Lora BW=125KHz_SF = 12_CR=4/5

Note: According to the design of the module, the maximum bit of register 0x09 must be set as 1. PaSelect must be set 1;

RegPaConfig (0x09)	7	PaSelect	rw	0x00	Selects PA output pin 0 → RFO pin. Output power is limited to +14 dBm. 1 → PA_BOOST pin. Output power is limited to +20 dBm
	6-4	MaxPower	rw	0x04	Select max output power: $P_{max}=10.8+0.6*MaxPower$ [dBm]
	3-0	OutputPower	rw	0x0f	$P_{out}=P_{max}-(15-OutputPower)$ if PaSelect = 0 (RFO pin) $P_{out}=17-(15-OutputPower)$ if PaSelect = 1 (PA_BOOST pin)

5. Schematic

Lora1276 V2.0

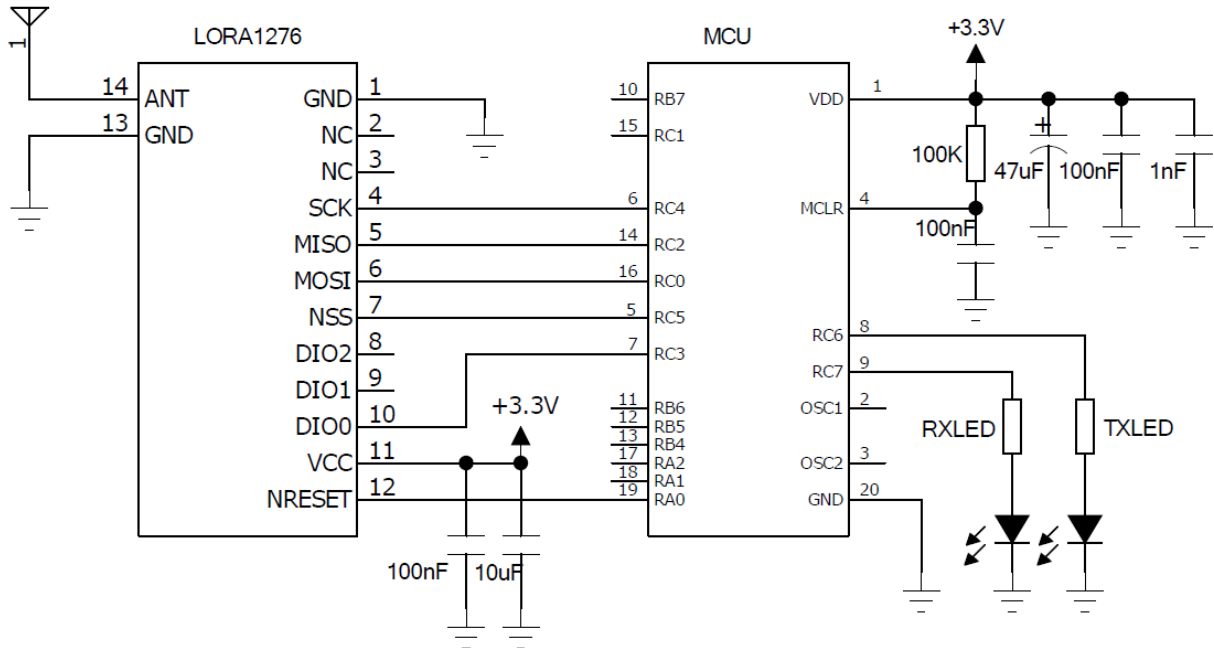

6. Speed rate correlation table

SingnalBandWidth	SpreadingFactor	Sensitivity(dbm)	ActualBandRate(bps)
62.5kHz	SF=7	-126	2169
62.5kHz	SF=8	-129	1187
62.5kHz	SF=9	-132	656
62.5kHz	SF=10	-135	296
62.5kHz	SF=11	-137	164
62.5kHz	SF=12	-139	91
125kHz	SF=7	-123	4338
125kHz	SF=8	-126	2375
125kHz	SF=9	-129	1312
125kHz	SF=10	-132	733
125kHz	SF=11	-133	328
125kHz	SF=12	-136	183
250kHz	SF=7	-120	8676
250kHz	SF=8	-123	4750
250kHz	SF=9	-125	2624
250kHz	SF=10	-128	1466
250kHz	SF=11	-130	778
250kHz	SF=12	-133	366
500kHz	SF=7	-118	17353
500kHz	SF=8	-121	9501
500kHz	SF=9	-124	5249
500kHz	SF=10	-127	2932
500kHz	SF=11	-129	1557
500kHz	SF=12	-130	830

7. Pin definition

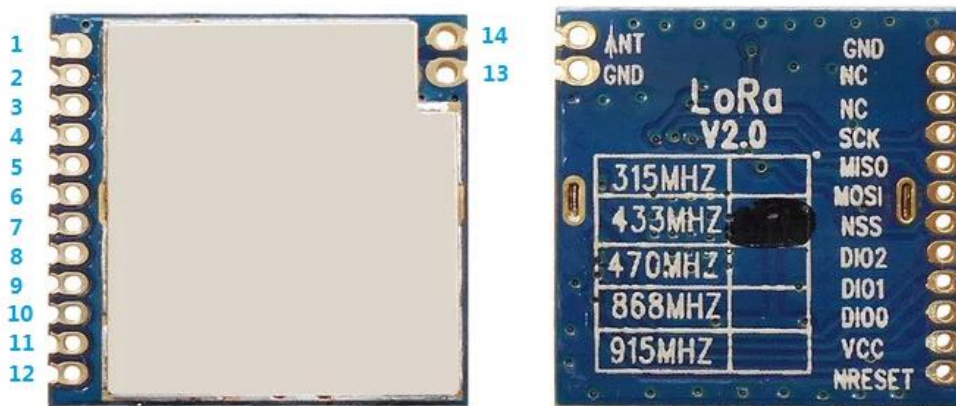

Lora1276 V2.0 Pin Assignment		
Pin NO.	Pin name	Description
1	GND	power ground
2	NC	Vacant
3	NC	Vacant
4	SCK	Serial clock for SPI interface
5	MISO	SPI Output for SPI data
6	MOSI	SPI Input for SPI data
7	NSS	SPI enable
8	DIO2	Digital I/O
9	DIO1	Digital I/O
10	DIO0	Digital I/O
11	VCC	Connected power supply (default 3.3V)
12	NRESET	Reset input
13	GND	power ground
14	ANT	Connect with 50 ohm coaxial antenna

Lora1276 V1.1 Pin Assignment		
Pin NO.	Pin name	Description
1	GND	power ground
2	TXEN	Antenna switch control, Tx: Txen = 1, Rxen = 0; Rx: Txen = 0, Rxen = 1; Sleep : Txen = Rxen = 0
3	RXEN	
4	SCK	Serial clock for SPI interface
5	MISO	SPI Output for SPI data
6	MOSI	SPI Input for SPI data
7	NSS	SPI enable
8	DIO2	Digital I/O
9	DIO1	Digital I/O
10	DIO0	Digital I/O
11	VCC	Connected power supply (default 3.3V)
12	NRESET	Reset input
14	GND	power ground
13	ANT	Connect with 50 ohm coaxial antenna

8. Accessories

1) Antenna

Antenna is very important for RF communication, its performance will affect the communication directly. Module needs antenna in 50ohm. Common antenna has rubber straight/ elbow/ foldable rod and sucker antenna and etc. Users can order accordingly. To ensure module in the best performance, we suggest to use the our antenna

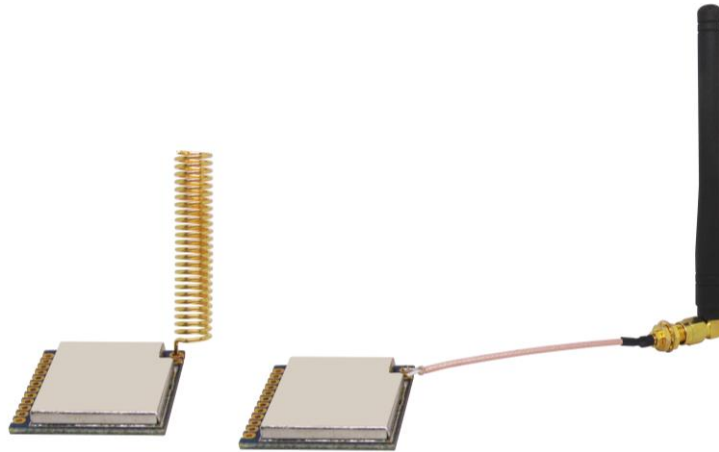

★To ensure modules get the best performance, user must obey the following principles when using the antennas:

- Put the antenna away from the ground and obstacles as possible as you could;
- If you choose the sucker antenna, pull straight the lead wire as possible as it can be, the sucker under arches should be attached on the metal object.

9. Mechanical Dimensions(Unit: mm)

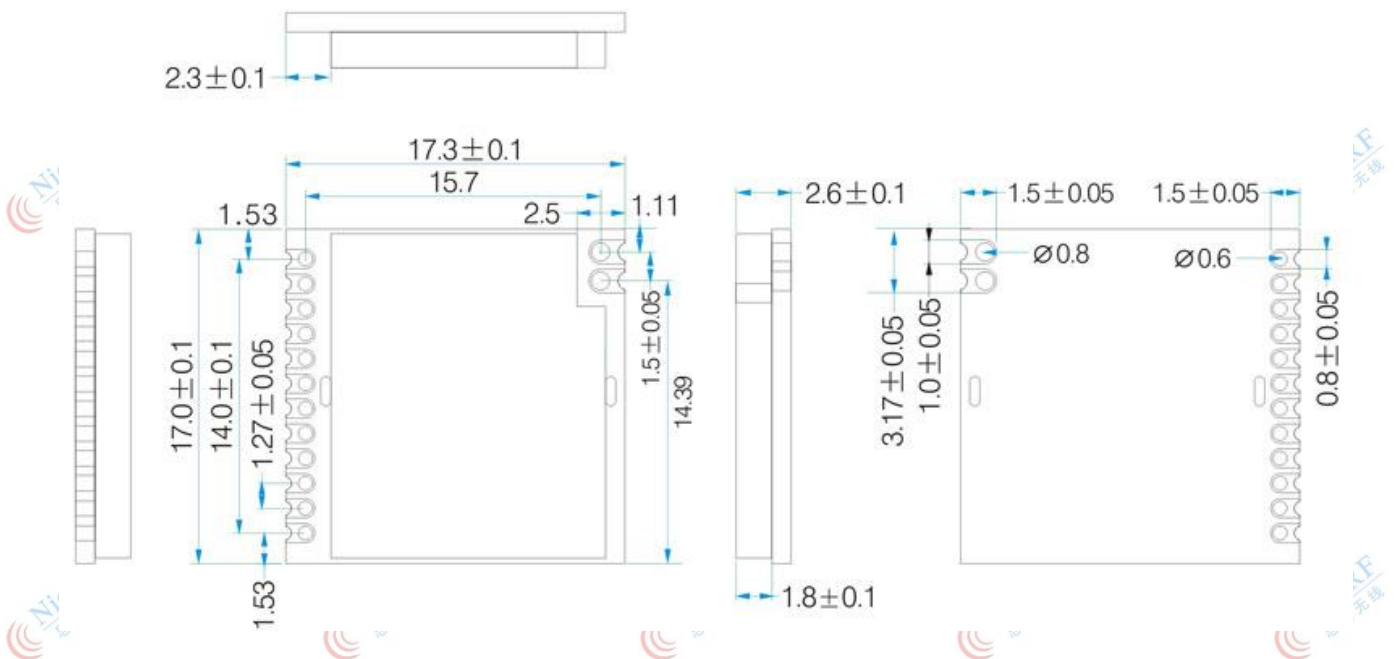

10. Order information

LoRa1276-868

Product name

Frequency

For example: If the customer needs 868MHz Frequency, the order no. shall be LoRa1276-868.

Here are the product types:

Product Name	Description
LoRa1276-868	Working frequency 868MHz
LoRa1276-915	Working frequency 915MHz

Appendix 1: SMD Reflow Chart

We recommend you should obey the IPC related standards in setting the reflow profile:

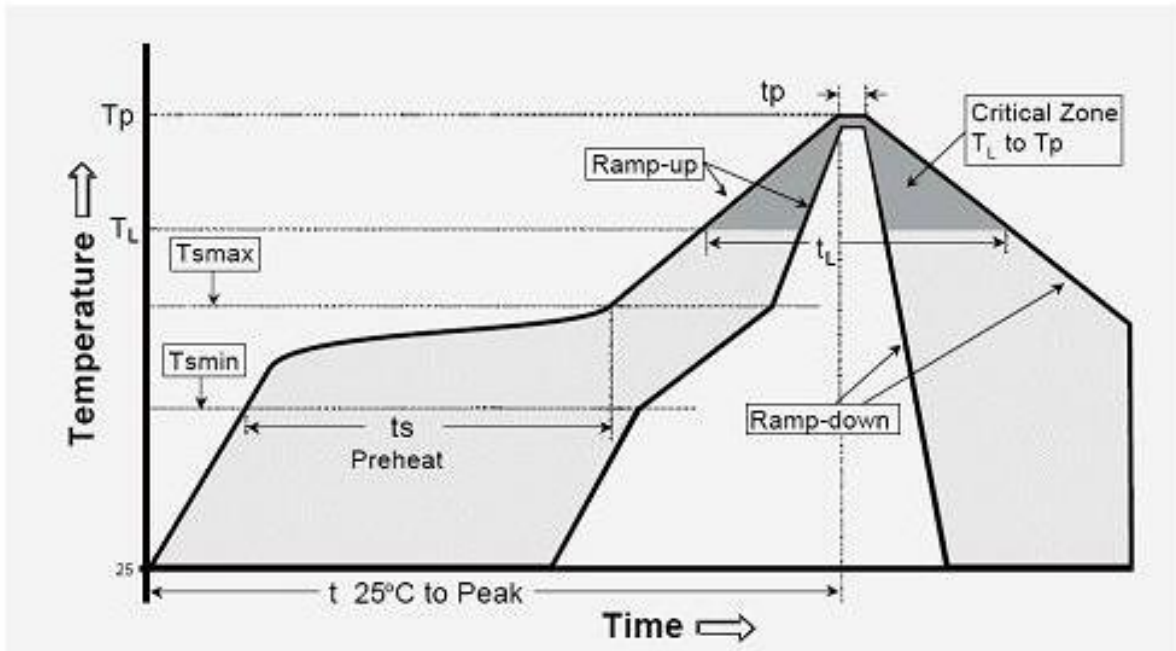

IPC/JEDEC J-STD-020B the condition for lead-free reflow soldering	big size components (thickness $\geq 2.5\text{mm}$)
The ramp-up rate (Tl to Tp)	3°C/s (max.)
preheat temperature	
- Temperature minimum (Tsmmin)	150°C
- Temperature maximum (Tsmmax)	200°C
- preheat time (ts)	60~180s
Average ramp-up rate(Tsmmax to Tp)	3°C/s (Max.)
- Liquidous temperature(TL)	217°C
- Time at liquidous(tL)	60~150 second
peak temperature(Tp)	245+/-5°C

Appendix 2: PCB board

The module is equipped with a standard DEMO board for customer to debug the program and test distance. The power supply voltage range: 3.3V~8.0V. It shows as below:

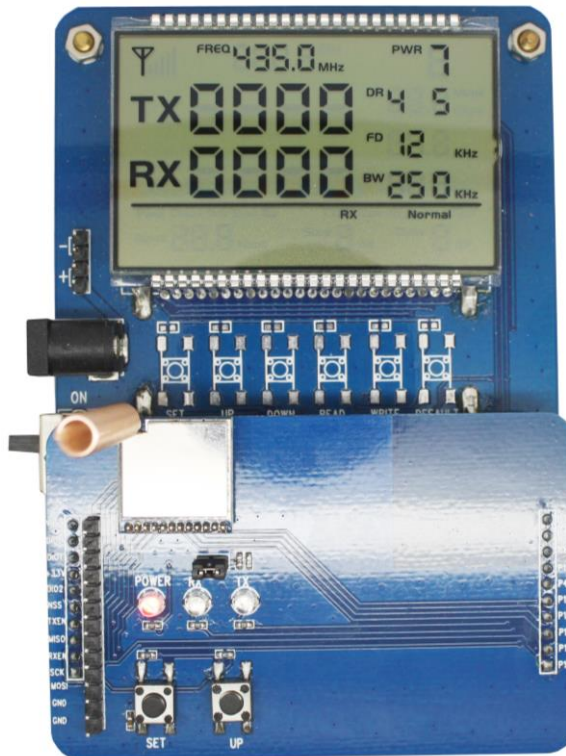

The LCD Full Segment is as below:

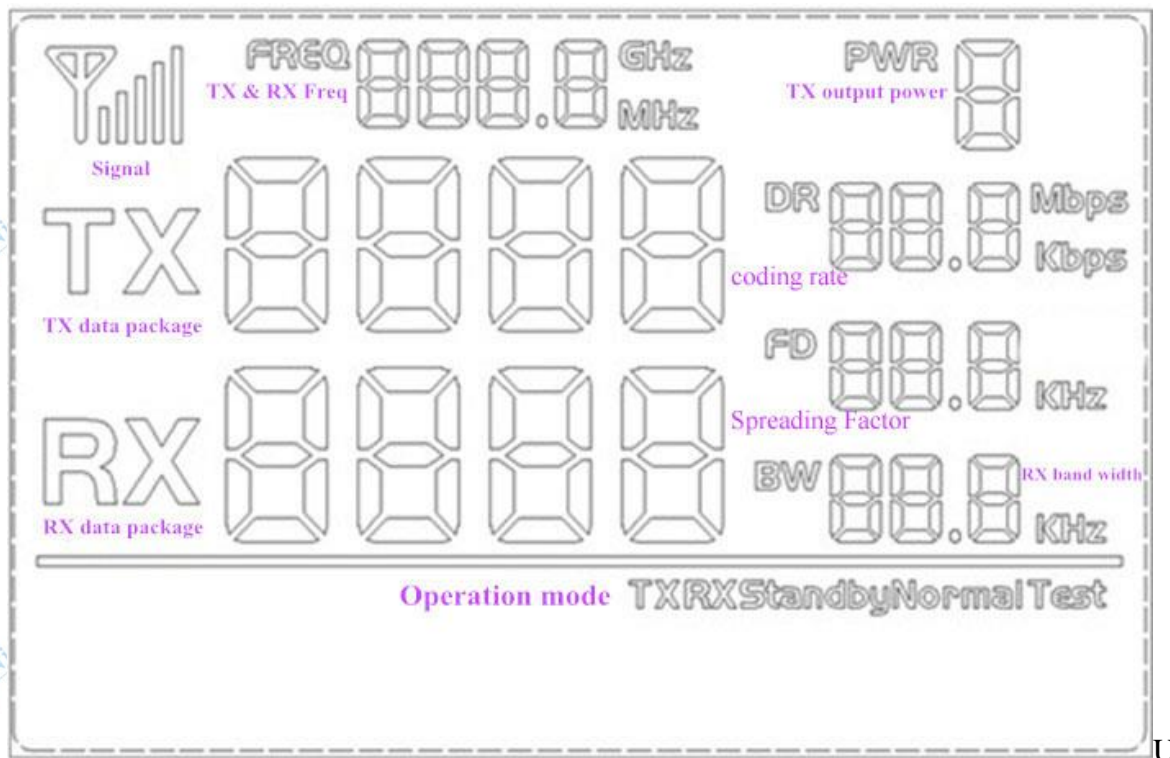

users can set the parameters of the RF module such as working mode /frequency /transmitter power / transmission data rate through the buttons, and measure the wireless communication distance.

➤ Working Mode

- 1) Master Mode: Send 1 packet per second, and waiting for the acknowledge;
- 2) Slave Mode: Stay in Rx mode to wait for the data from the master, it will send back
- 3) The acknowledged signal after received the data from the master.
- 4) Tx Test Mode: RF module continuously transmit signal;
- 5) Rx Test Mode: RF module is always in Rx mode;
- 6) Standby Mode: RF module is always in standby state.

➤ Button Operation

1) [SET] Button

Press the [SET] button to enter setting mode if not in setting mode. In setting mode, press [SET] button to toggle between the set parameters: working mode /frequency/ output power / data rate / spreading factor/ Bandwidth. The related LCD ICON will flash to indicate.

2) [UP] Button

In setting mode, press the [UP] button to increase the value of flash icon.

Note: The DEMO board has FLASH memory inside, all the setting parameters will behave automatically and keep unchanged even power-off.