

4 Channels, 1W Output Power
Remote Control RF Switch Module

Product Specification



Catalog

1.	Overview.....	- 3 -
2.	Features.....	- 3 -
3.	Applications.....	- 3 -
4.	Block Diagram.....	- 3 -
5.	Electrical Characteristics.....	- 4 -
6.	Interface.....	- 4 -
7.	DIP Definition.....	- 5 -
8.	Working Mode.....	- 6 -
1)	Real-time Mode.....	- 6 -
2)	Timing Mode.....	- 6 -
3)	Configuration Mode.....	- 7 -
9.	Application Connection.....	- 8 -
10.	Pin Definition.....	- 10 -
11.	Accessories.....	- 11 -
12.	Mechanical Measurement.....	- 12 -
13.	Order Information.....	- 12 -
14.	FAQ.....	- 13 -

Note: Revision History

Revision	Date	Comment
V1.0	2013-10-12	First release
V2.0	2014-9-5	Revised some parameters
V3.0	2015-4-25	Add descriptions in pictures
V3.1	2017-06	Logo updated

1. Overview

SK108H is a industrial four channels wireless switch controller with hopping function, it provides maximum four channel signal input and maximum four channel control output. It features simple interface and reliable performance. The parameters can be modified by PC software / UART command / remote controller (SK108-S). DIP switch on the module can used to change operating frequency (maximum 16 group), operation mode etc. Using this module, user can replace wired device with the wireless connection, which significantly reduce the cost and save much time.

2. Features

- Frequency hopping algorithm
- Up to 3Km line-of-sight in open area
- 16 predefined channels
- Parameters configurable by PC software/ Remote controller/ UART Command
- Real-time/Timing working mode for optional
- GFSK modulation
- Bi-directional wireless switch control
- Anti-interference
- Sensitivity up to -121 dBm
- Maximum output power: 1 W
- Indicate and alarm when battery low
- Working voltage 9 ~ 30 V
- Working temperature range: - 40 ~ + 85 ° C
- Weight: 143g

3. Applications

- Remote control switch control
- Security system
- Home automation remote sensing
- Wireless remote telemetry
- Building automation and security
- Access control system

4. Block Diagram

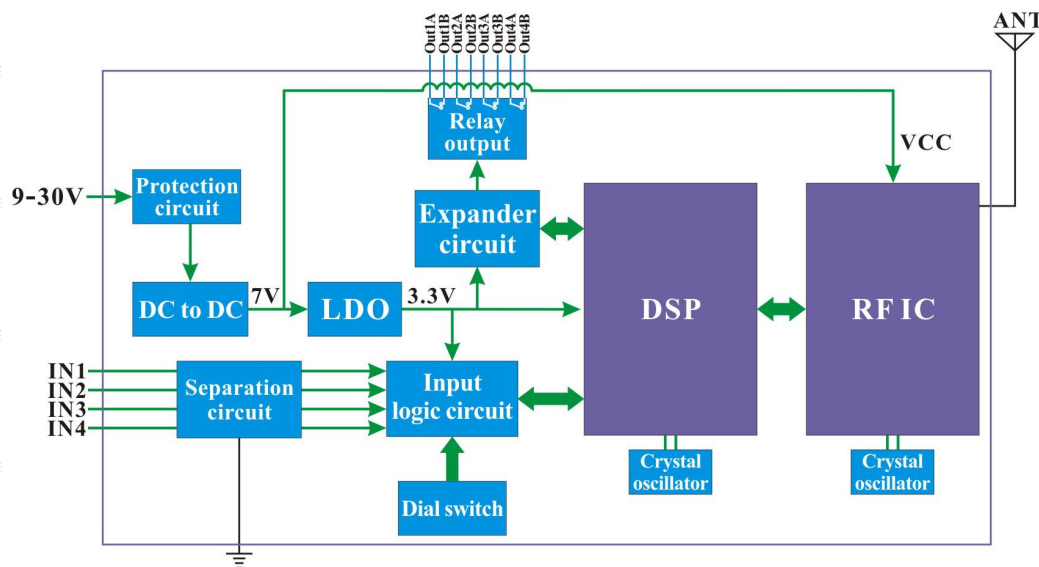

5. Electrical Characteristics

Note: Below parameters base on 12V power supply/ 25°C testing environment.

Parameters	Min.	Typ.	Max.	Unit	Condition
Working condition					
Voltage range	9	12	30	V	
Operating Temperature	-40	25	+85	°C	
Current consumption					
Rx current		<20		mA	
Tx current		<200		mA	
Sleep current		<7		mA	@12V Timing mode Non transmitting
RF parameters					
Output power		30		dBm	
Sensitivity		-121		dBm	

6. Interface

The description of interfaces as below:

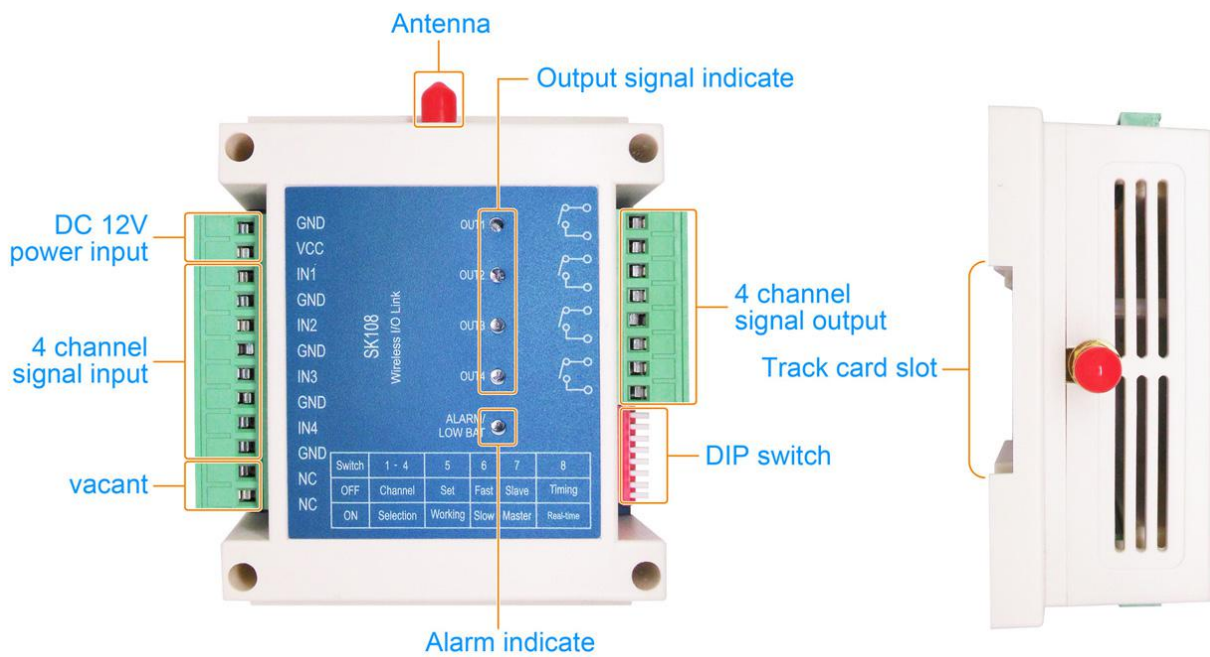

7. DIP Definition

Dip switch Settings (valid when power on again)

DIP8—Normal working mode selection

ON—Real-time mode (In this mode, when state changes in input port , it transmit signal immediately)

OFF—Timing mode (Signal transmitted at the predefined time interval according to the setting of DIP6)

DIP7—master/slave selection

ON—the master

OFF—the slave

DIP6—Time interval selection of timing mode

ON—Slow time (configurable, default 30S)

OFF—Fast time (configurable, default 2S)

















DIP5—Mode selection

ON—Normal working mode

OFF—Configuration mode (Wireless setting on PC via configuration module K108-S)

DIP4~1 —Working frequency channel selection, total 16 channels(default channel interval: 0.5M), frequency is configurable through PC software / UART Command/ Remote controller SK108.

Relationship between DIP switch and working frequency channel:

DIP NO.	Channel No.	DIP NO.	Channel No.	DIP NO.	Channel No.	DIP NO.	Channel No.
	1		5		9		13
	2		6		10		14
	3		7		11		15
	4		8		12		16

8. Working Mode

Module can work in the following three modes:

1) Real-time Mode

In real-time mode, it is a bi-directional communication. The change of input will be synchronized to the output of the module in other side.

Each module has four independent input and four independent output. In real-time mode, the change of any input of the four channels will trigger the transmission, in other side the corresponding relay of the module will be synchronized after got the signal, then it returns a acknowledged signal. If no acknowledged signal come to the triggered modules, the alarm LED will light on. All the output relays will be resumed open if no acknowledge signal received for continuous 3 times inquiry.

For example, communication between modules A and B,

the 4 output of module A is corresponding to the 4 input of module B,

the 4 output of module B is corresponding to the 4 input of module A, shown as below:

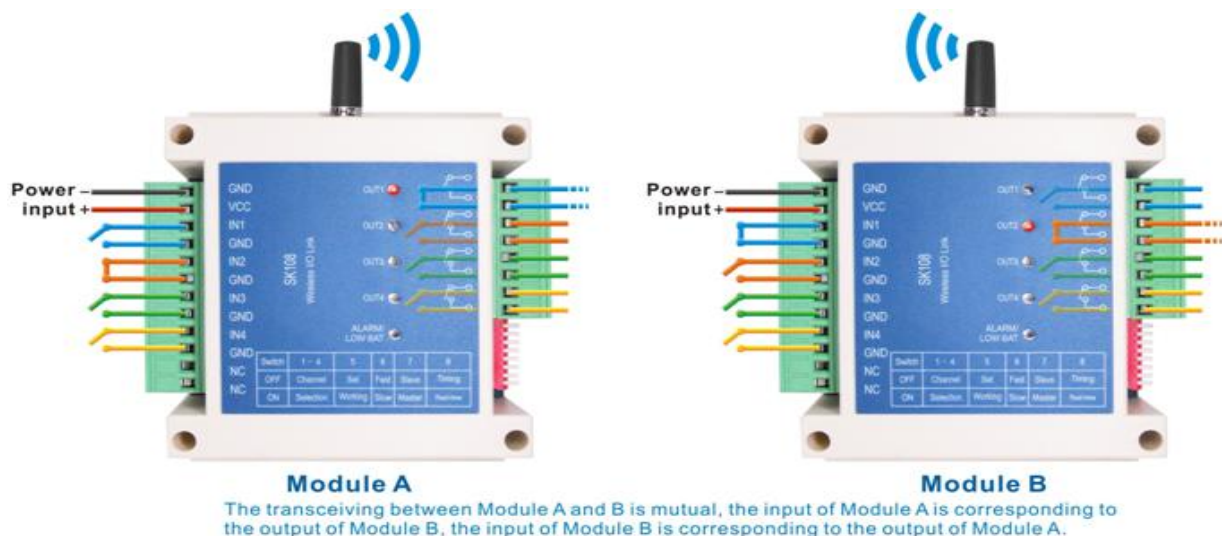

In real time mode, the modules worked in master mode, and the other side worked in slave mode. The slave module will send inquiry signal at fixed time interval , master will send the synchronized message accordingly. The alarm LED will light on and all the four output relay will resume to 0 (all relays are in open state) if no synchronized message received for continuous 3 times. The LED will indicate low battery and all the four output relay will resume to 0 (all relays are in open state) if get low battery signal from the other side;

Note: Under this working mode, please don't power on the master and slave at the same time.

2) Timing Mode

In timing mode, the module works in master mode or slave mode. The communication is one way.

Communication is from master to slave. The master transmits the wireless signal to slave regularly, the corresponding relay of the slave will be synchronized after got the signal.

The module can worked in fast mode or slow mode by changing the dip switch. The time interval of the fast or slow mode can be configured by PC software (default is 2s in fast mode, 30s in slow mode). The alarm LED will light on and all the four output relay will resume to 0 (all relays are in open state) if no synchronized message received for continuous 5 times interval. The LED will indicate low battery and all the four output relay will resume to 0 (all relays are in open state) if get low battery signal from the other side;

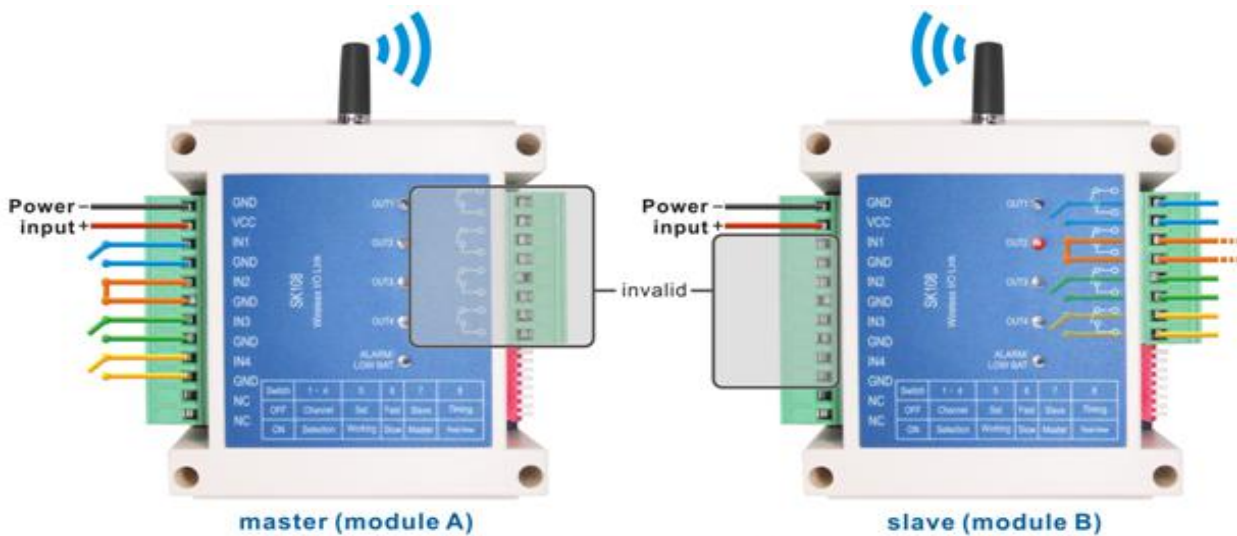

Communication is from master to slave, the 4 input of module A is corresponding to the 4 output of module B. The 4 output of master and the 4 input of slave are invalid.

3) Configuration Mode

In configuration mode, user can configure the parameters by SK108-S or PC software. The configurable parameters include NET ID, RF data rate, 16 groups frequency channels, slave inquiry time interval (only available in real time mode), master transmitting time interval (Only available in timing mode), modules can communicate with each other when parameters matched. PC software show as below:



◇ CHANNEL

Each module has 16 frequency channels, users can choose one of the channels to use via DIP switch, the corresponding frequency of the 16 channels can be modified via PC software. We suggest users using the default frequency value, or set the frequency value near the centre frequency to get better performance.

◇ Inquiry Time

This parameter is used in real time mode. The slave send the inquiry signal to master with this fixed inquiry time interval. 1 byte length, unit is minute.

◇ Fast

It is used in Timing mode. 1 byte length, unit is second.

◇ Slow

It is used in Timing mode. 1 byte length, unit is second.

9. Application Connection

The input port is pulled up internally, leave open or connect with 3.3V will result in high level, it is low level when connect to GND.

High level will make the output of the other side short out. And low level will make the output of the other side open. Below is regular connection:

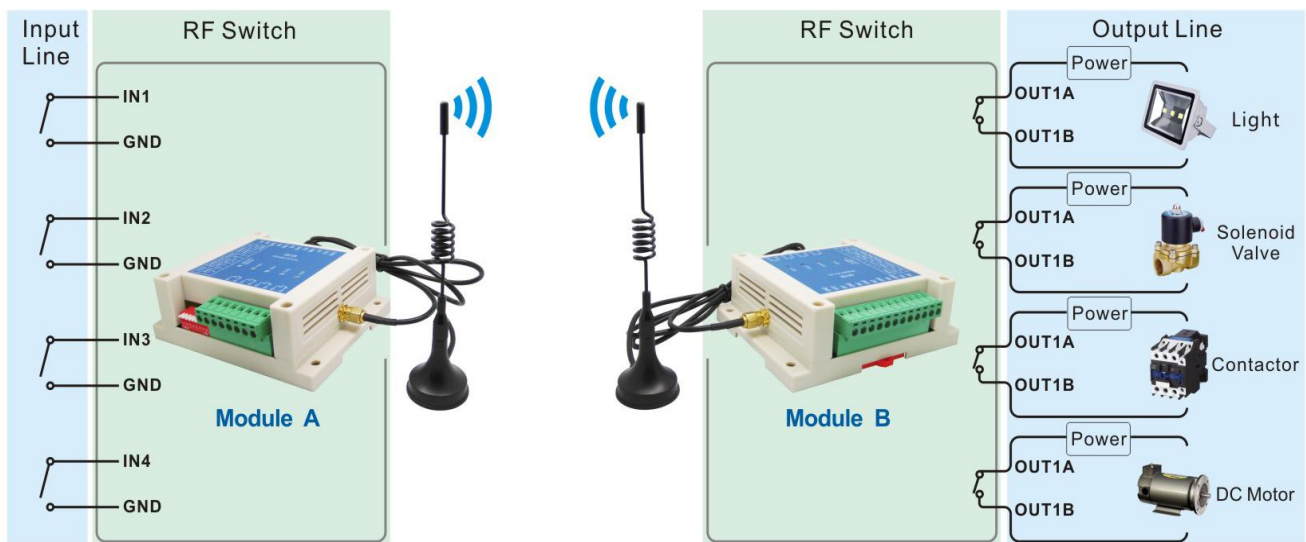

Shorts between INx of A and GND, OUTx relay of B will be actuation, Open INx from GND, OUTx relay of B will open.

★ Input and output status under normal working mode:

The relationship between input in one side and output in other side:

Real-time mode (bi-communication)				Timing mode (One way communication)			
Master input		Slave output		Master input		Slave output	
IN1	Open or pull high	OUT1	Open	IN1	Open or pull high	OUT1	Open
	Short		Close		Short		Close
IN2	Open or pull high	OUT2	Open	IN2	Open or pull high	OUT2	Open
	Short		Close		Short		Close
IN3	Open or pull high	OUT3	Open	IN3	Open or pull high	OUT3	Open
	Short		Close		Short		Close
IN4	Open or pull high	OUT4	Open	IN4	Open or pull high	OUT4	Open
	Short		Close		Short		Close
Slave input		Master output		Slave input		Master output	
IN1	Open	OUT1	Open	IN1	X	OUT1	Open
	Short		Close		IN2		
IN2	Open	OUT2	Open	IN3		X	
	Short		Close		IN4	X	
IN3	Open	OUT3	Open				
	Short		Close				
IN4	Open	OUT4	Open				
	Short		Close				
Master input		Slave output (Master is battery low)		Master input		Slave output (Master is battery low)	
IN1	Open	OUT1	Open	IN1	Open	OUT1	Open
	Short				IN2		
IN2	Open	OUT2		IN3		Open	
	Short				IN4	Short	
IN3	Open	OUT3					
	Short						
IN4	Open	OUT4					
	Short						
Slave input		Master output (Slave is battery low)		Slave input		Master output (Slave is battery low)	
IN1	Open	OUT1	Open	IN1	X	OUT1	Open
	Short				IN2		
IN2	Open	OUT2		IN3		X	
	Short				IN4	X	
IN3	Open	OUT3					
	Short						
IN4	Open	OUT4					
	Short						

10. Pin Definition



Pin NO.	Pin	Description
1	GND	Power Ground
2	VCC	Connect to positive power
3	IN1	Ch1 input, internal pull up
4	GND	
5	IN2	Ch2 input, internal pull up
6	GND	
7	IN3	Ch3 input, internal pull up
8	GND	
9	IN4	Ch4 input, internal pull up
10	GND	
11	NC	Reserved, Non-Connected
12	NC	Reserved , Non-Connected
13	OUT1	Ch1 relay control output,
14		closed : low level in Tx Open : high level in Tx
15	OUT2	Ch2 relay control output,
16		closed : low level in Tx Open : high level in Tx
17	OUT3	Ch3 relay control output,
18		closed : low level in Tx Open : high level in Tx
19	OUT4	Ch4 relay control output,
20		closed : low level in Tx Open : high level in Tx

11. Accessories

1) Antenna

The antenna is very important for RF communication. Its performance will affect the communication. The module requires the antenna with 50Ω impedance. Spring antenna is used commonly, but straight / elbow /folding/bar antenna and sucker antenna can be used with Coaxial cable.. User can choose the right antenna according to their application. We advise to use antennas listed on our website to get better performance.



★Tips for antenna:

- Don't close to the ground, metal, magnet, big current;
- If you are using the sucker antenna, pull the wire as straight as possible, the sucker foundation should stick with metal.

2) Power supply

The standard power supplier for this module is DC 12V(suggest to using current in 1A or higher), module will not work when voltage is lower than 9V. Power supply is very important for this module, its performance will affect the communication. We suggest to use our standard power supply to get better performance.



12. Mechanical Measurement(Unit:mm)

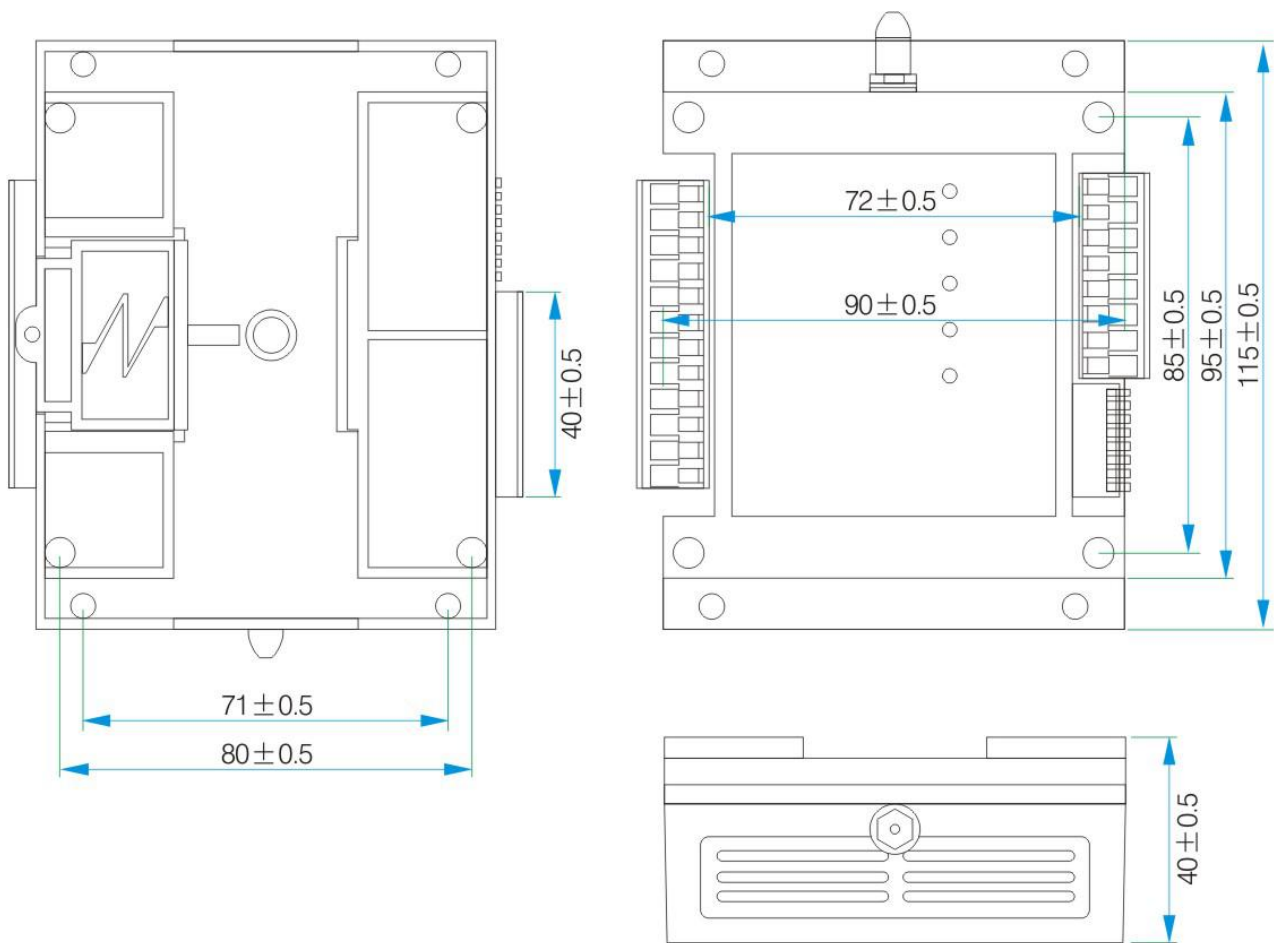

13. Order Information

SK108-433
└ centre frequency

For example: If the customer needs 433MHz, part number of released order shall be: SK108-433

SK108 has below versions:

Item NO.	Description
SK108-433	Center frequency 433MHz
SK108-490	Center frequency 490MHz
SK108-868	Center frequency 868MHz
SK108-915	Center frequency 915MHz

14. FAQ

- a) Why modules can't communicate?
- 1) Check if power supply is connected correctly
 - 2) Check if module in normal communication mode;
 - 3) Check if the frequency ,channel,NET ID and air rate of each module are the same
 - 4) Check if module is damaged (if the LED flash when powered on?)
- b) Why communication distance is not so far as expected?
- 1) Check if the Power supply is stable ;
 - 2) Check if the antenna well matched and install properly;
 - 3) Check if the surrounding environment is good;
 - 4) Check if strong same frequency interference existed;